



SEALING THE DEAL

Complete access solutions for HVAC

DESIGNED FOR ALL CLIMATES AND APPLICATIONS

When designing an HVAC unit, there are many things to consider. Will it be used in a cold or warm climate? Will it be exposed to the sun, rain, snow, salt water or sand? Will there be a weekly need for access to the technology inside? Are there any specific security aspects to consider?

Industrilas Klima-flex™ is the most comprehensive latching system for HVAC applications available today. It contains surface-mounted and through-mounted systems, handles, latching hinges, hinges and accessories. In combination with our assortment of sealing profiles, Klima-flex delivers a straightforward and safe access solution for all types of insulated, double-skinned and pressurized doors.

Klima-flex is also a product family designed for people. It is just as easy and timesaving to install, as it is a breeze to handle. The distinct functional qualities ensure smooth operation indoors and outdoors, in all climates and harsh environments, such as offshore.

SERVING THE INDUSTRY

Industrilas has been developing and manufacturing access solutions for the HVAC industry for over 40 years. All with total control over the production chain, from design and manufacturing to final surface treatments and assembly.

Today, we have a presence in more than 40 countries and have manufacturing sites in Europe, Asia and Central America. The group's head office is located in Nässjö, Sweden.

Industrilas – when access counts

CONTENT

KEEPING THE PRESSURE JUST RIGHT	4	ACCESSORIES	22
INDUSTRILAS KLIMA-FLEX™ 2	6	INDUSTRILAS VISION™ OUTSIDE INSULATED	24
INDUSTRILAS KLIMA-FLEX™ 1	10	DELIVERING ACCESS EXCELLENCE	26
INDUSTRILAS KLIMA-FLEX™ LATCH HINGES	16	A MORE SUSTAINABLE TOMORROW	28
INDUSTRILAS KLIMA-FLEX™ HINGES.....	18	WORLDWIDE PRESENCE.....	30
PROFILES.....	21		



KEEPING THE PRESSURE JUST RIGHT

The most crucial aspect of a latching solution for HVAC units is that it ensures the cabinet is sealed properly. This will keep the inside air pressure at the appropriate level, creating a highly functioning and more energy efficient HVAC unit. To achieve this, all parts of the latching solution must deliver the same quality and meet specific needs and requirements.

Industrilas Klima-flex™ and Industrilas accessories offer a multitude of options and make sure there is always a package that will suit your application. If you have specific needs or wishes regarding your solution, our in-house design department is always ready to assist you.

Industrilas glass fibre reinforced polyamide (PA6GF30) is certified VDI6022, according to ISO 846. This means the material is resistant to bacterial growth, a very important aspect in heating, ventilation and cooling equipment.

RANGE OF SOLUTIONS

HANDLES

For inswing and outswing doors, with several locking options and available in glass fibre reinforced polyamide, stainless steel and acid-proof stainless steel.

HINGES

Many versions and sizes, and adjustable in two or three dimensions.

INSIDE HANDLES

Opens large units from the inside.

INTELLICLAMPS

Connect several units and secure their alignment.

SEALING PROFILES

Correct compression prevents any air leakage.

SAFETY CATCH

Lets the unit decompress before opening the door fully.

BRIDGE CLAMPS

Latches for units that are not opened often.

LATCH UNITS

For through-mounted and surface-mounted systems.

ROLLER CAMS

Reduce friction and increase gasket compression.

INSPECTION WINDOWS

Allow optical inspection without opening the door.

TEST PORT

For sampling the air pressure without opening the door.

LATCH HINGES

Enable opening to the right, to the left or complete removal of the door.

RODS

Enable connection of two or more latch points.

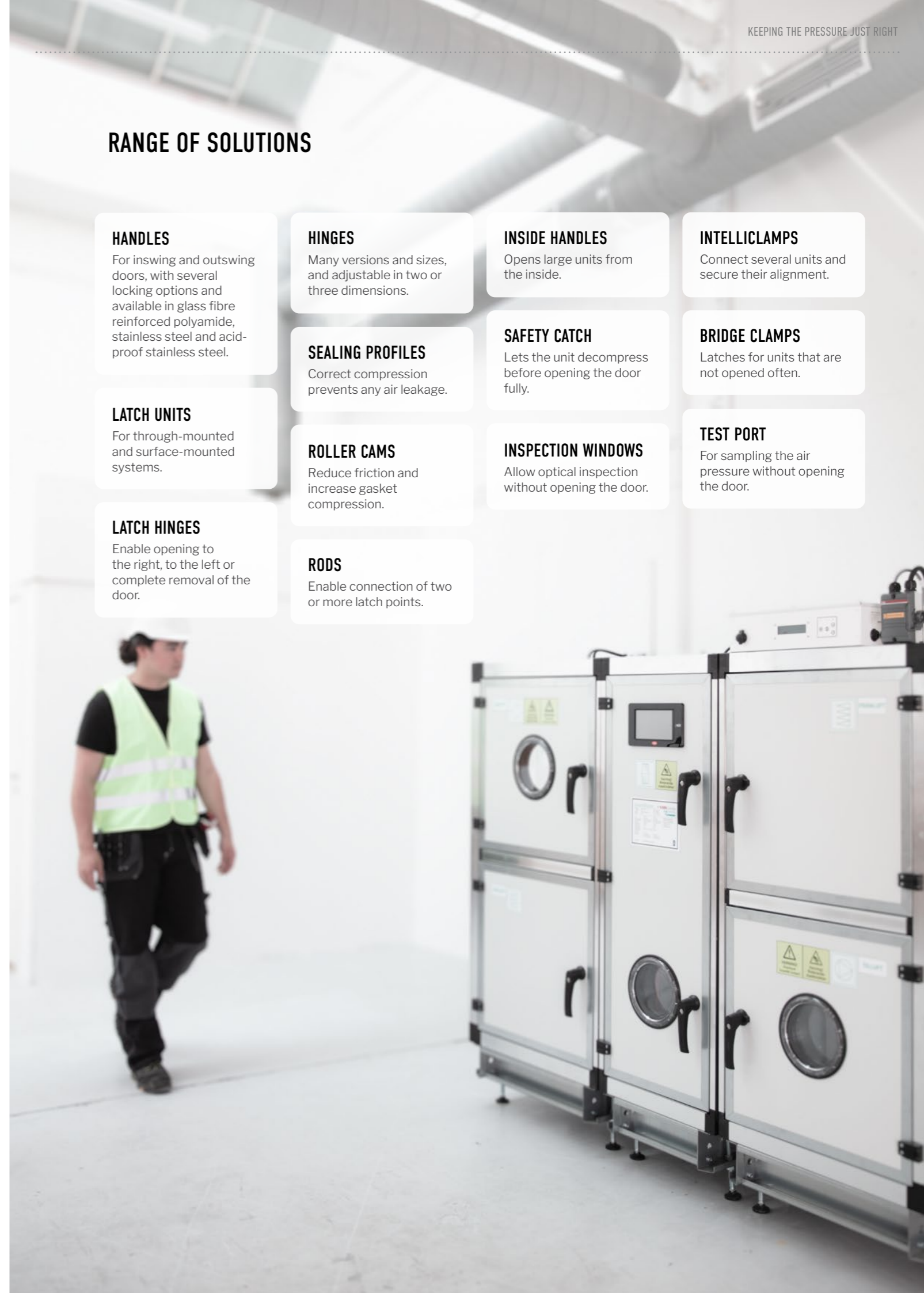

INDUSTRILAS KLIMA-FLEX™ 2

When you need the ultimate sealing performance, our patented Klima-flex 2 is the one to choose. The system includes both surface-mounted and through-mounted options.

Klima-flex 2 has been designed with installation in mind, and the system can be fully installed with just one tool – a Torx 30.

DESIGNING YOUR SYSTEM

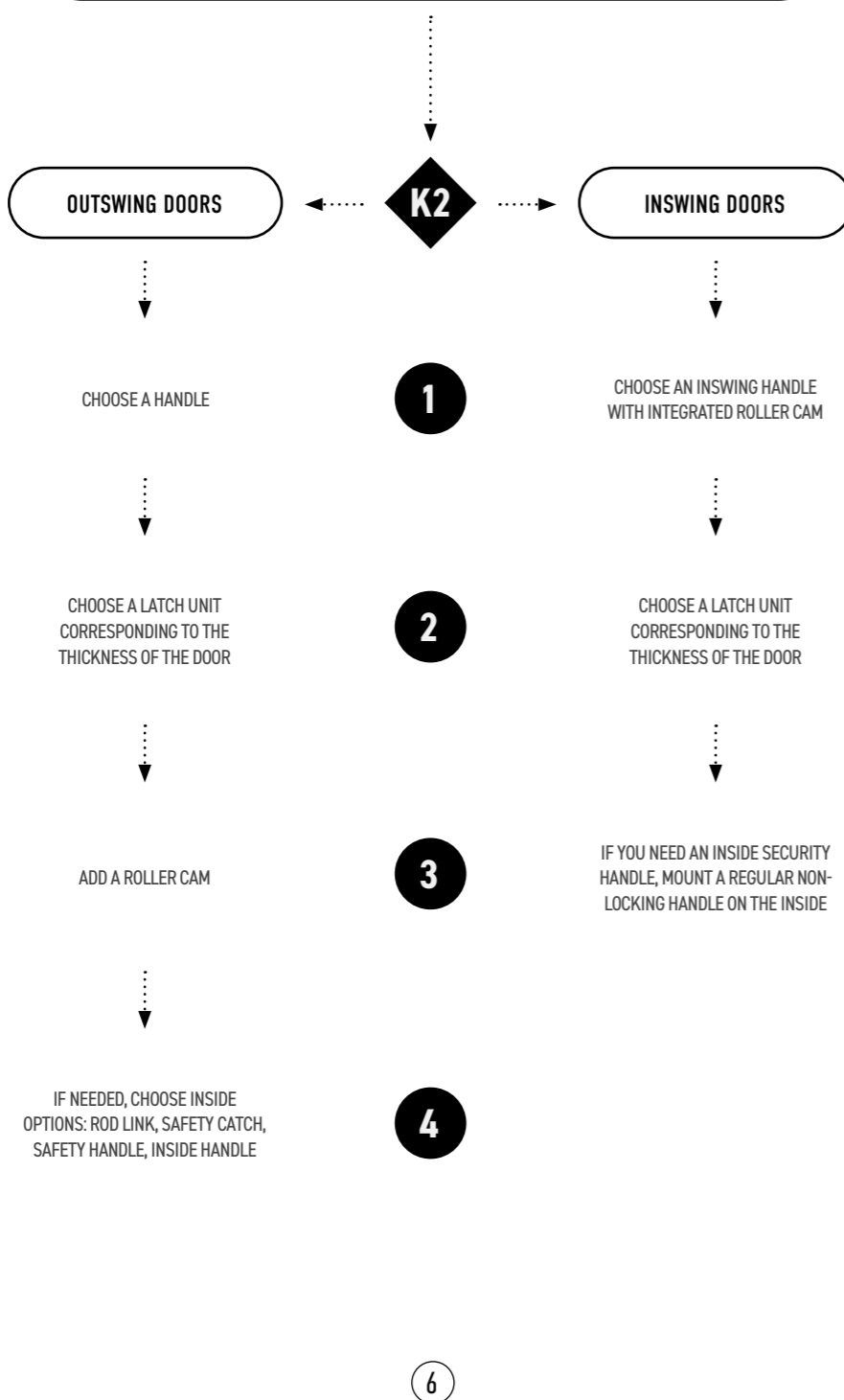

OUTSWING DOOR

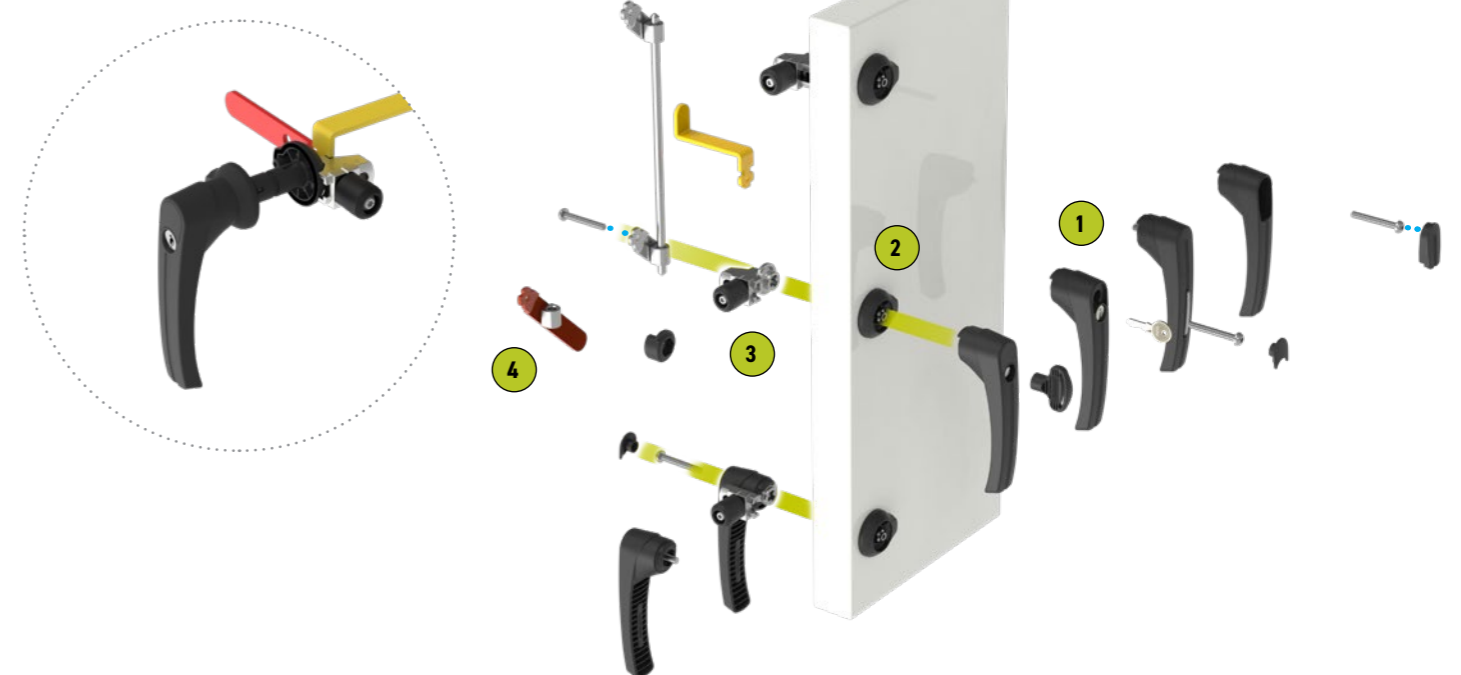

INSWING DOOR

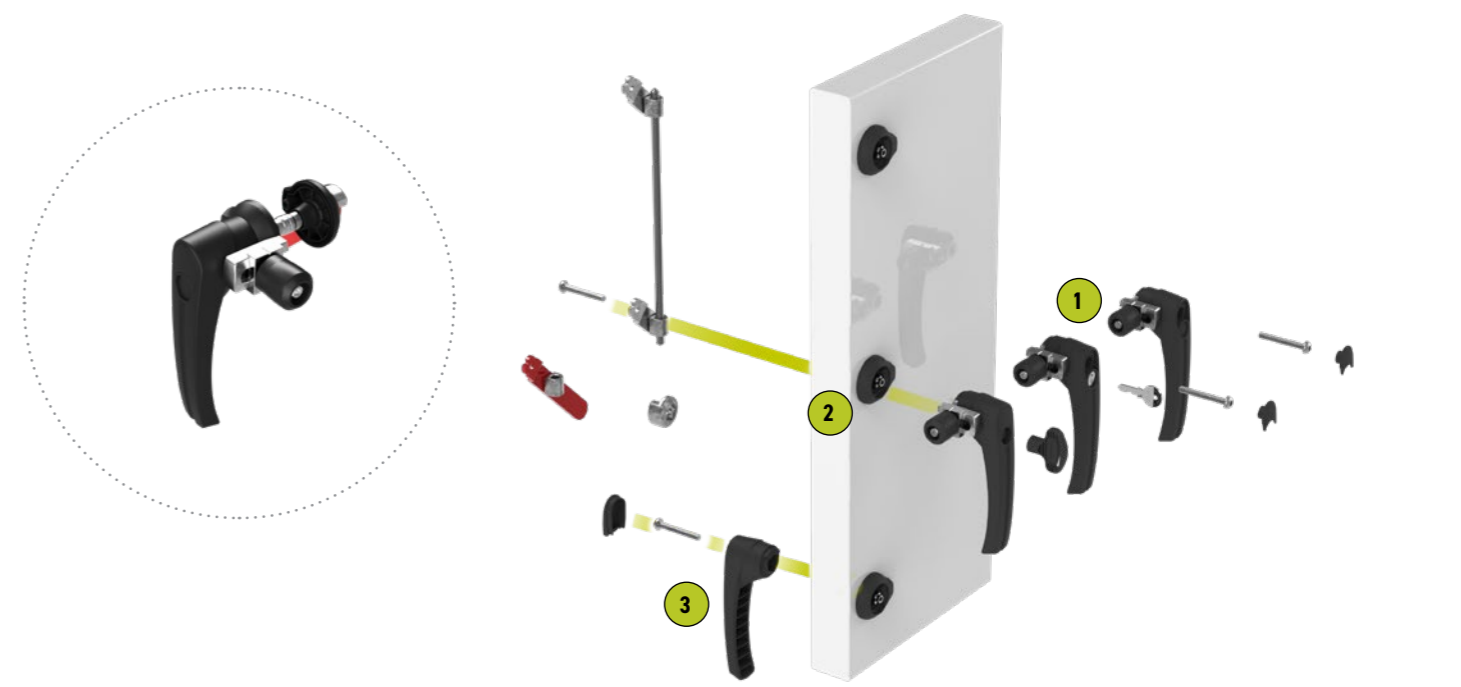

KLIMA-FLEX 2 HANDLE

The ergonomic Klima-flex 2 Handle is designed for simplicity in mounting. It can be used on both the inside and outside of the door and there are four versions: tool operated, key locking, pad-lockable and non-locking.

The handle for inswing doors has a built-in adjustable roller cam that reduces friction and increases gasket compression.

To reduce the risk of damage during transportation, all Klima-flex handles can easily be attached onsite, at the final destination of the HVAC unit.

Manufactured in glass fibre reinforced polyamide.

KLIMA-FLEX 2 LATCH UNIT

The patented technology of the latch unit is the key feature of the Klima-flex 2 system and allows quick installation in double-skinned doors. When you turn the screw, expanding legs are engaged and fix both door skins from the inside, eliminating the risk of bulging and possible air leakage.

The latch unit is available for door thickness from 25–100 mm.

KLIMA-FLEX 2 ROLLER CAM

Adjustable or fixed roller cam that ensures smooth and secure opening and closing of the door, as well as optimal compression against the sealing profile. It is quick to install and the cast-in scale on the side of the cam makes adjustment easy.

If you desire, you can connect several roller cams to be operated by one handle.

KLIMA-FLEX 2 SURFACE-MOUNTED LATCH UNIT

The surface-mounted Klima-flex 2 handle is a system specially designed for outswing doors. The smooth operation is thanks to the roller cam and miniature rollers between cam and housing. Rigid three-hole mounting and optimal cam support ensure reliable gasket compression over time. The handle distinctly clicks into open and closed positions.

If you want an inside release handle, safety catch or rod link, the solution is also available in a through-mounted version.

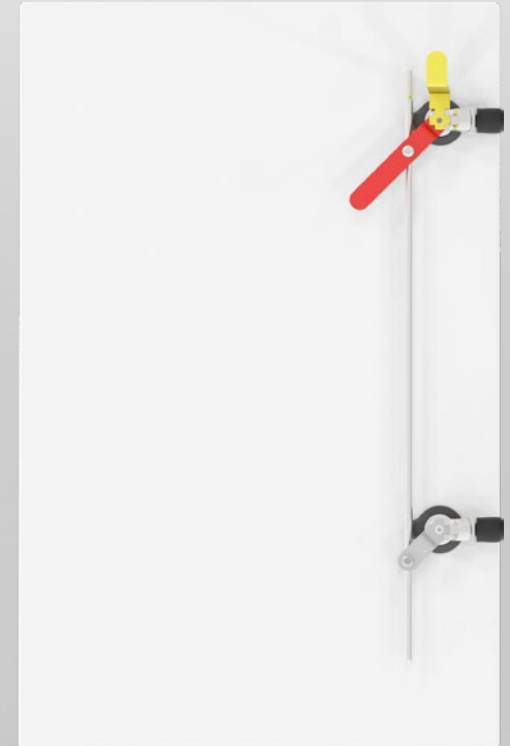
**KLIMA-FLEX INTERLINK ROD**

To operate two or more latch units with one handle, the rods can be connected with an interlink rod and rod links. The rod link clamps onto the interlink rod, enabling you to connect several latching units to one handle.

KLIMA-FLEX 2 SAFETY CATCH

For pressurized HVAC units, the safety catch prevents the door from flying open and accidentally injuring the operator when the door is opened.

In the Klima-flex 2 system you can combine a safety catch, rod link and/or inside security handle with the inside roller cam.

KLIMA-FLEX 2 INSIDE HANDLE

Walk-in HVAC units need an emergency handle installed on the inside of the door. In the Klima-flex 2 system you can combine a safety catch, rod link and/or inside security handle with the inside roller cam. The inside handle can be delivered with or without a fastened rod link.

KLIMA-FLEX 2 ROD LINK

With the use of rod links you can connect two or more latch points.

INDUSTRILAS KLIMA-FLEX™ 1

A system of well-proven and flexible solutions that can be installed regardless of door thickness or whether the door opens inwards or outwards. Klima-flex 1 includes a variety of latching units, handles and inside safety options, as well as an acid-proof, stainless steel solution.

The system includes both surface-mounted and through-mounted options.

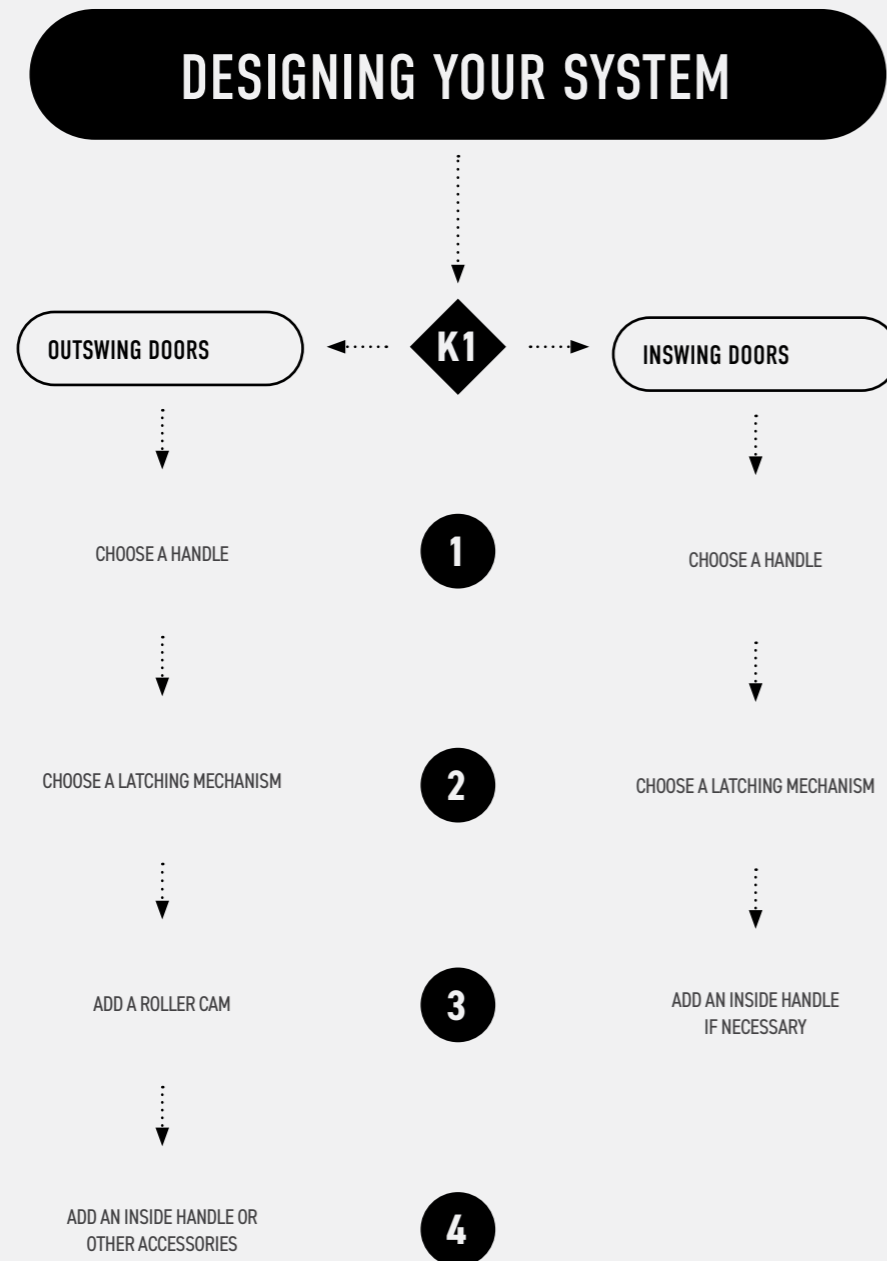

OUTSWING DOOR

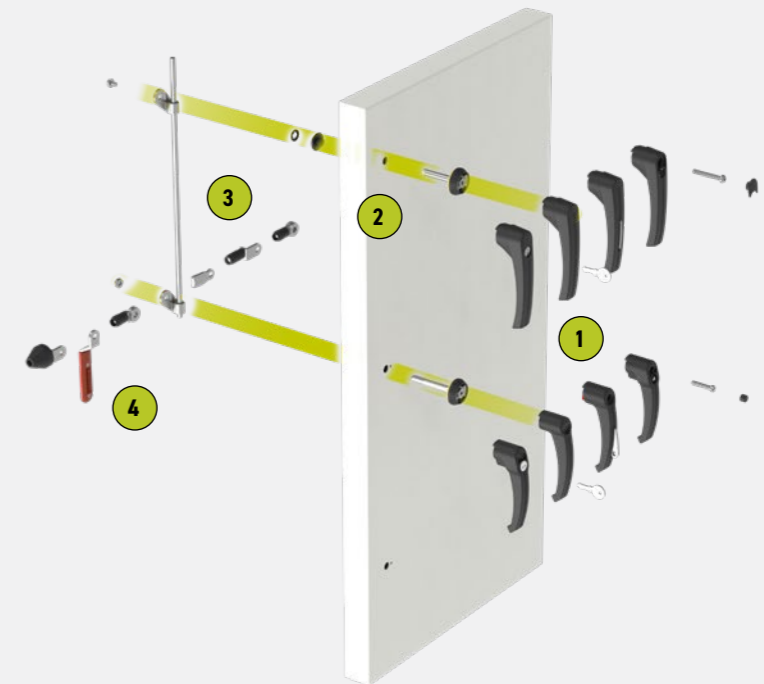
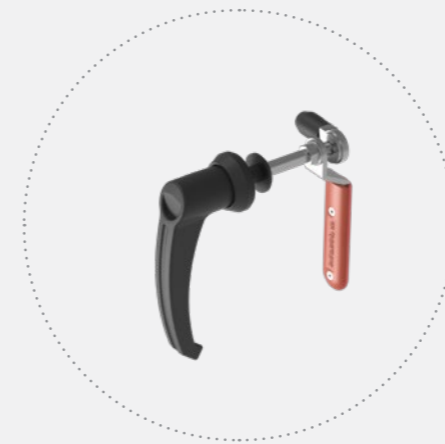

INSWING DOOR

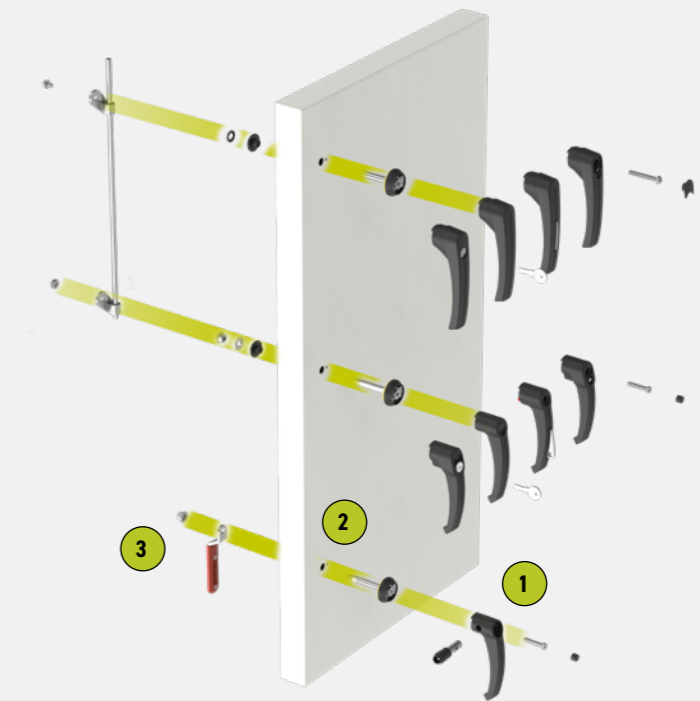
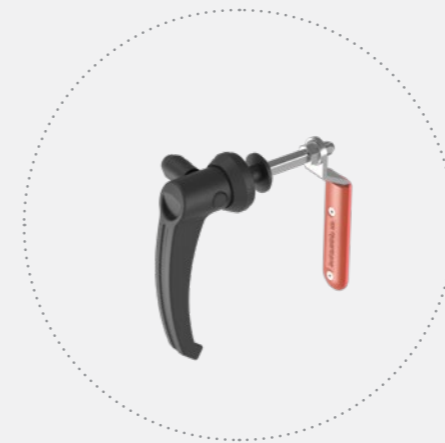

HANDLES

Klima-flex handles fit both outswing and inswing doors. They are available in four locking options: tool-operated, pad-lockable, key-locking and non-locking. Check the individual handles to find the one most suited to your requirements.

To reduce the risk of damage during transport, Klima-flex handles can easily be attached onsite, at the final destination of the HVAC unit.

KLIMA-FLEX 1 HANDLE

Handle for both outswing and inswing doors. Handles for inswing doors are supplied with a customized roller cam. The handle is manufactured in glass fibre reinforced polyamide. Available in tool-operated, key-locking, pad-lockable and non-locking versions.

KLIMA-FLEX 1 ACID-PROOF LATCHING SYSTEM

A complete acid-proof stainless steel latch and handle configuration. This corrosion resistant solution is perfectly suited for demanding applications in harsh environments, such as offshore. Available in a pad-lockable version.

KLIMA-FLEX 1 LATCH UNIT

The latch unit is available several lengths and in two cut-out versions: Combi and K-Flex. Combi is fixed with a spacer nut and K-Flex is fixed with a cam, a regular nut or a starlock washer. Depending on your needs for inside hardware, various latch units are available to meet your requirements.

KLIMA-FLEX 1 LATCH UNIT STAINLESS STEEL

Available in several lengths. The cam can be placed anywhere on the threaded area of the shaft using counter nuts. The latch unit is fixed with a starlock washer and can be combined with all inside options.



KLIMA-FLEX 2 HANDLE FOR KLIMA-FLEX 1 LATCH

With these handles you can equip your Klima-flex 1 latching solution with Klima-flex 2 handles. The handles are manufactured in glass fibre reinforced polyamide. Available in tool-operated, key-locking, pad-lockable and non-locking versions.

KLIMA-FLEX 1 METAL HANDLE

Metal handle that fits all Klima-flex 1 latch units. The handle is manufactured in die-cast zinc with a black powder coating. Available in a non-locking version.

KLIMA-FLEX 1 ACID-PROOF HANDLE

Corrosion resistant handle in acid-proof stainless steel 316. Fits all latch units in the Klima-flex 1 series and is available in pad-lockable and non-locking versions.

KLIMA-FLEX 1 SURFACE MOUNTED LATCH UNIT

Latch unit for outswing doors, supplied with or without an adjustable, surface mounted striker. The latch point may be combined with all Klima-flex 1 handles.

KLIMA-FLEX 1 LATCH UNIT INSWING DOOR

Easily operated latch unit for inswing doors. Mounted with screws or rivets.



INSIDE OPTIONS



KLIMA-FLEX 1 INSIDE HANDLE

Inside handle for Klima-flex 1. When the handle is used as an emergency handle it should only be combined with non-locking latch units.

Manufactured in stainless steel or zinc plated steel, with grip in glass fibre reinforced polyamide



KLIMA-FLEX 1 SAFETY CATCH

For pressurized HVAC units, the safety catch prevents the door from flying open and accidentally hitting the operator when the door is opened. The safety catch captures the door while positive air pressure escapes and then, when the secondary knob is turned, the door is opened safely. The safety catch is compatible with all handles in the Klima-flex 1 system.



KLIMA-FLEX 1 ROLLER CAM

Roller cams are designed for smooth operation – they reduce operational friction and increase gasket compression. They are easy to install and are available in several sizes and shapes.



KLIMA-FLEX 1 ROD LINK

Rod links are used to operate two or more latch units with one handle. The remote latch units are connected to the handle using interlink rods and rod links.



KLIMA-FLEX INTERLINK ROD

To operate two or more latch units with one handle, the rods can be connected with an interlink rod and rod links. The rod link clamps onto the interlink rod, enabling you to connect several latching units to one handle.



INDUSTRILAS KLIMA-FLEX™ LATCH HINGES

If you do not want or need a traditional handle to operate the door, latch hinges are a great choice. They are totally surface mounted and thus leave the inner door skin intact.

Latch hinges give you the opportunity to open the door 180° both left and right, as well as removing the door completely.

Klima-flex latch hinges are patented and designed for the best user experience.

KLIMA-FLEX LATCH HINGE GEN2

This robust latch hinge is adjustable vertically, creates 6 mm of compression and is available in three locking versions: tool-operated, key-locking and non-locking.

The built-in safety catch provides a safe two-stage opening process that allows the cabinet to depressurize before it is fully opened.

Latch hinge Gen2 has a smooth geometry that provides excellent ergonomic operation, with a distinct click that delivers tactile feedback in the open and closed positions.

Manufactured in die-cast zinc and glass fibre reinforced polyamide, with hinge pin in stainless steel.



KLIMA-FLEX COMPACT LATCH HINGE

The compact latch hinge can be adjusted in all three directions, creates 3 mm of compression and is tool-operated. A unique feature lets you adjust the compression by an additional 1.5 or 3.0 mm, if needed.

The latch hinge can be delivered with or without a safety catch. When using a safety catch, the cabinet is allowed to depressurize before it is fully opened.

Manufactured in glass fibre reinforced polyamide.



INDUSTRILAS KLIMA-FLEX™ HINGES

To ensure there is no air leakage, insulated doors need to have the correct gasket compression. It is therefore crucial to use hinges that are created specifically for this purpose.

Klima-flex hinges are adjustable and available with a mounting bracket, to ensure stability. They are easily combined with all Klima-flex 1 and Klima-flex 2 latching systems.



KLIMA-FLEX EXTENDED ADJUSTABLE 2D-HINGE 180°

Surface-mounted hinge that is adjustable in the X- and Y-axis by 3 mm. 180° opening angle. Lift-off feature when lower hinge part is removed. Supplied with mounting plate for thin door skins. Manufactured in die-cast zinc. Zinc plated, chrome plated, or black texture coated. This hinge has an extended door part compared to Klima-flex Adjustable 2D Hinge 180°



KLIMA-FLEX ADJUSTABLE 2D-HINGE 180° STAINLESS STEEL

Adjustable in the X- and Y-axis by 3 mm. 180° opening angle. Supplied with mounting plate. Manufactured in stainless steel 304.



KLIMA-FLEX HEAVY-DUTY ADJUSTABLE 3D-HINGE 180°

Surface-mounted heavy-duty hinge. Adjustable in the X- and Y-axis by 6 mm and in the Z-axis by 3 mm. 180° opening angle. Lift-off feature when lower hinge part is removed. Supplied with adjustment screws and fastening plate for thin door skins. Manufactured in die-cast zinc. Zinc plated, chrome plated, or black texture coated.



KLIMA-FLEX ADJUSTABLE 3D-HINGE 180°

Adjustable in the X-, Y- and Z-axis by 3 mm. 180° opening angle. Supplied with adjustment screws and fastening plate. Manufactured in die-cast zinc. Zinc plated or black texture coated.



KLIMA-FLEX ADJUSTABLE LIFT-OFF HINGE 180°

This lift-off hinge is designed to be used with Klima-flex Latch Hinge Gen2. It allows universal right and left mounting, with 180° opening angle. When the door is in the open position, the smart quick-release function allows you to easily remove the door and door attachment without using any tool. The hinge is mounted on the surface of the frame and door with rivets or screws. Manufactured in die-cast zinc and glass fibre reinforced polyamide. Black zinc plated and black texture coated.



KLIMA-FLEX ADJUSTABLE 2D-HINGE 180°

Specifically designed hinge that simplifies mounting on insulated doors. Adjustable in the X- and Y-axis by 3 mm. 180° opening angle. Lift-off feature when lower hinge part is removed. Supplied with mounting plate. Manufactured in die-cast zinc. Zinc plated or black texture coated.



KLIMA-FLEX HINGE 180°

Classic hinge for insulated doors. Mounted using rivets or screws. Universal right or left mounting. Manufactured in glass fibre reinforced polyamide.

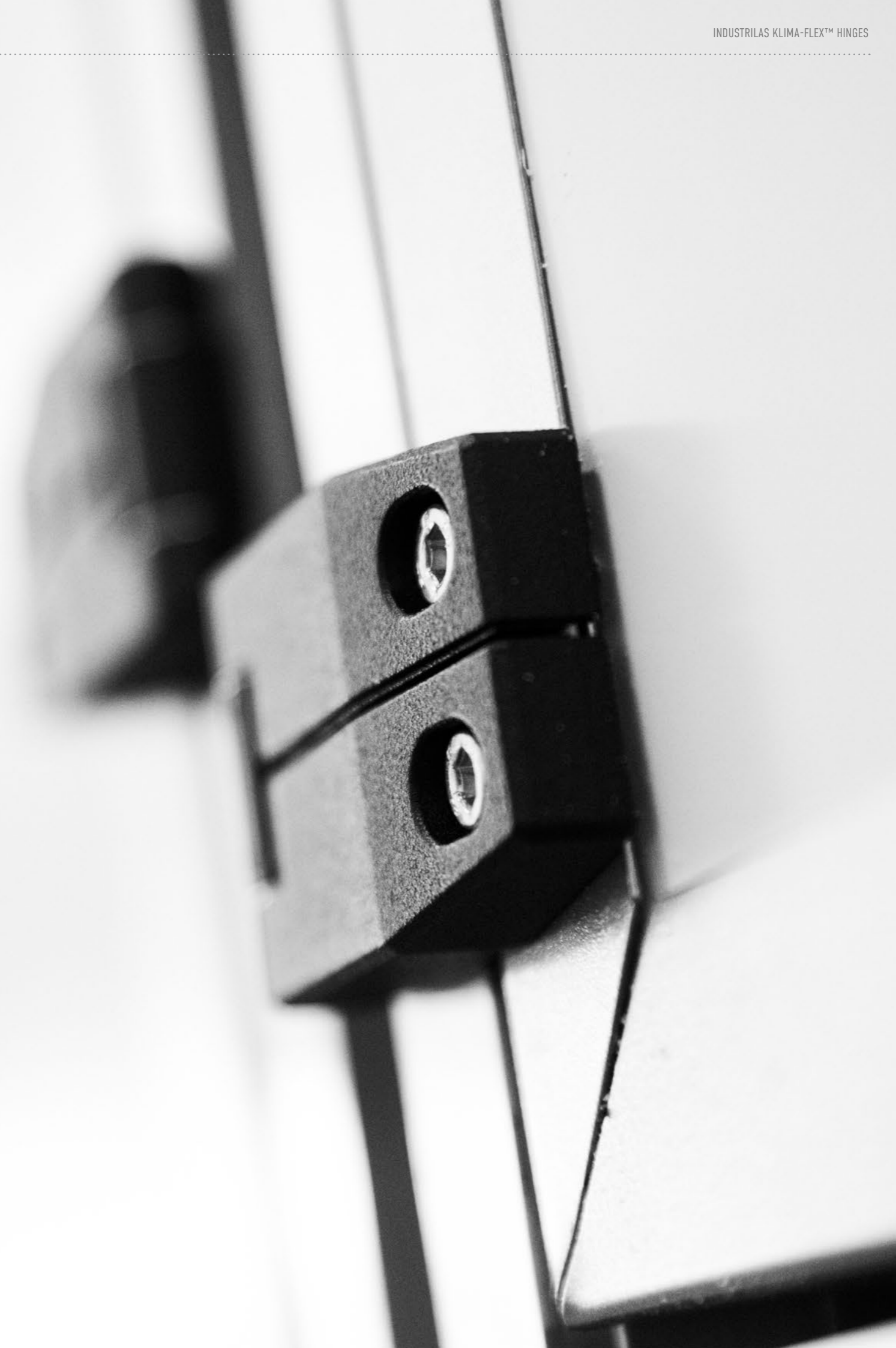



PROFILES

Choosing the right profile is vital for achieving correct sealing and compression. Profiles are available in many different shapes, sizes and materials, and we guarantee that we have one that lives up to your needs and requirements. If requested, we can cut profiles in fixed lengths to fit your applications. We can also offer profile frames with glued or vulcanized corners, ready to install on your door or door frame.

All Industrilas EPDM clip-on profiles are certified according to UL94HB. And if needed, we can provide profiles in materials with even higher fire resistance classifications.

Sealing profiles can be delivered certified according to VDI 6022. These profiles are hygienically accepted and manufactured from a soft solid EPDM compound that is resistant to bacterial growth. This aspect is very important in heating, ventilation and cooling equipment.

PROFILE MATERIAL

- × Ethylene Propylene Diene Monomer (EPDM)
- × Natural rubber (NR)
- × Nitrile rubber (NBR)
- × Polychloroprene (CR)

PROFILE SOLUTIONS

- × Sealing profiles
- × Edge protection profiles
- × Glazing profiles
- × Self-adhesive gasket profiles

ACCESSORIES

When designing your HVAC unit there are several accessories that can come in handy, such as inspection windows, connectors, bridge clamps, test ports and lighting units.



INTELLICLAMP 3D

Intelliclamps are used to connect several units or building elements. Each Intelliclamp 3D consists of two interlocking halves, a bolt and a nut. The halves are mounted on the separate units, and as the bolt is tightened, the two units are perfectly aligned in the X-, Y- and Z-axis. Each half is mounted on the separate units using rivets or screws.

Manufactured in die-cast zinc, either zinc plated or black texture coated. Available in two sizes: 50x50 mm and 40x80 mm.



INTELLICLAMP 3D MULTIFUNCTIONAL CONNECTOR

This patent-pending solution enables perfect concealed alignment of several units, creating a great looking set.

Each half of the connector is mounted on the inside corners of two units, where they stabilize the separate units at a 90° angle. When the connectors are then interlocked, they secure and align the units in the X-, Y- and Z-axis.

Manufactured in die-cast zinc and glass fibre reinforced polyamide.



KLIMA-FLEX BRIDGE CLAMP WITH WING KNOB

Bridge clamp for closing doors and panels. Available in two versions: with M8- or M6-threaded wing knob.

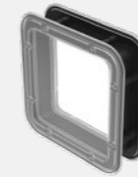

INSPECTION WINDOW SQUARE

Square inspection window in transparent, impact-resistant polycarbonate. The window is equipped with an integrated gasket and is suitable for units with positive or negative pressure. Simple mounting by using eight self-tapping stainless screws. Mounting screws are included.

Water- and dustproof according to IP66. Manufactured with a UV-stabilized polycarbonate window and foam rubber EPDM seal. Available for door thicknesses between 40–60 mm.



INSPECTION WINDOW CIRCULAR

Circular inspection window in transparent polycarbonate. The window is equipped with gaskets on both sides and is suitable for units with positive or negative pressure. Simple mounting using six self-tapping screws. Mounting screws are included.

Manufactured with a polycarbonate window and PVC seal. Available for door thicknesses between 30–60 mm.



HVAC LIGHT FOR INSPECTION WINDOW

Practical, powerful lighting solution that can be used with Industrilas Inspection Window Square. It consists of a rigid plastic housing with tailored TPE seal. The circuit board is equipped with 6 white LEDs that are powered by 2 AAA batteries in an integrated battery compartment. High-quality batteries are included.

Pressing the switch lights up the LEDs for 30 seconds. This prevents the batteries from being drained unintentionally. Alternatively, an external power supply can be soldered onto the circuit board. The power supply should provide 500 mA at 5V. A cable passage is provided on the seal.

The LED unit is for indoor HVAC units and can be mounted in four positions on the viewing window. Screws for different door thicknesses are included.



KLIMA-FLEX BRIDGE CLAMP DUAL DOORS

Dual bridge clamp for closing doors and panels. One bridge clamp keeps panels on both sides of the frame in place. Available in two versions: with M8- or M6-threaded wing knob.



KLIMA-FLEX BRIDGE CLAMP COMPACT

Bridge clamp for recessed closing doors and panels. Available with M6-threaded wing knob or hexagon screw with press nut.



TEST PORT FOR HVAC APPLICATIONS

Allows the user to test the air pressure in a ventilation system without the need to open the door. The port is secured with screws on the surface of the door skins. The longer test port, for 100 mm thick doors, can easily be adapted to thinner doors by simply cutting it to the required length.

INDUSTRILAS VISION™ OUTSIDE INSULATED

Industrilas Vision™ Outside Insulated is a specially adapted version of the Industrilas Vision™ systems, for HVAC and telecom applications where insulated or double-skinned doors are used.

The system is designed for enclosures that are equipped with climate control (HVAC, HEX etc). The system is hidden inside the insulated door, providing a thermal break and preventing condensation.

The latch points consist of a protruding frame part and a receptacle hidden on the inside of the door.

ADVANTAGES OF VISION OUTSIDE INSULATED

- × Allows an insulated door to be opened, closed and locked in a high-quality manner
- × Concealed mounting resulting in an aesthetically appealing design
- × The latching mechanism is located outside the sealed door area, resulting in a door design with no cut-outs in critical areas
- × Because the door is latched it is fixed in all axes (X, Y and Z), ensuring a vault-like latching performance
- × Direct load transfer from frame to door, i.e. no oscillations from load transfer via rods. Vision Outside Insulated ensures that the door is correctly aligned before the gasket is compressed. No shearing or side loads on the gasket mean better sealing performance and longer gasket life
- × The system complies with the strictest global test requirements for vibration, torque and corrosion, for use in Zone 4 telecom equipment applications and similar

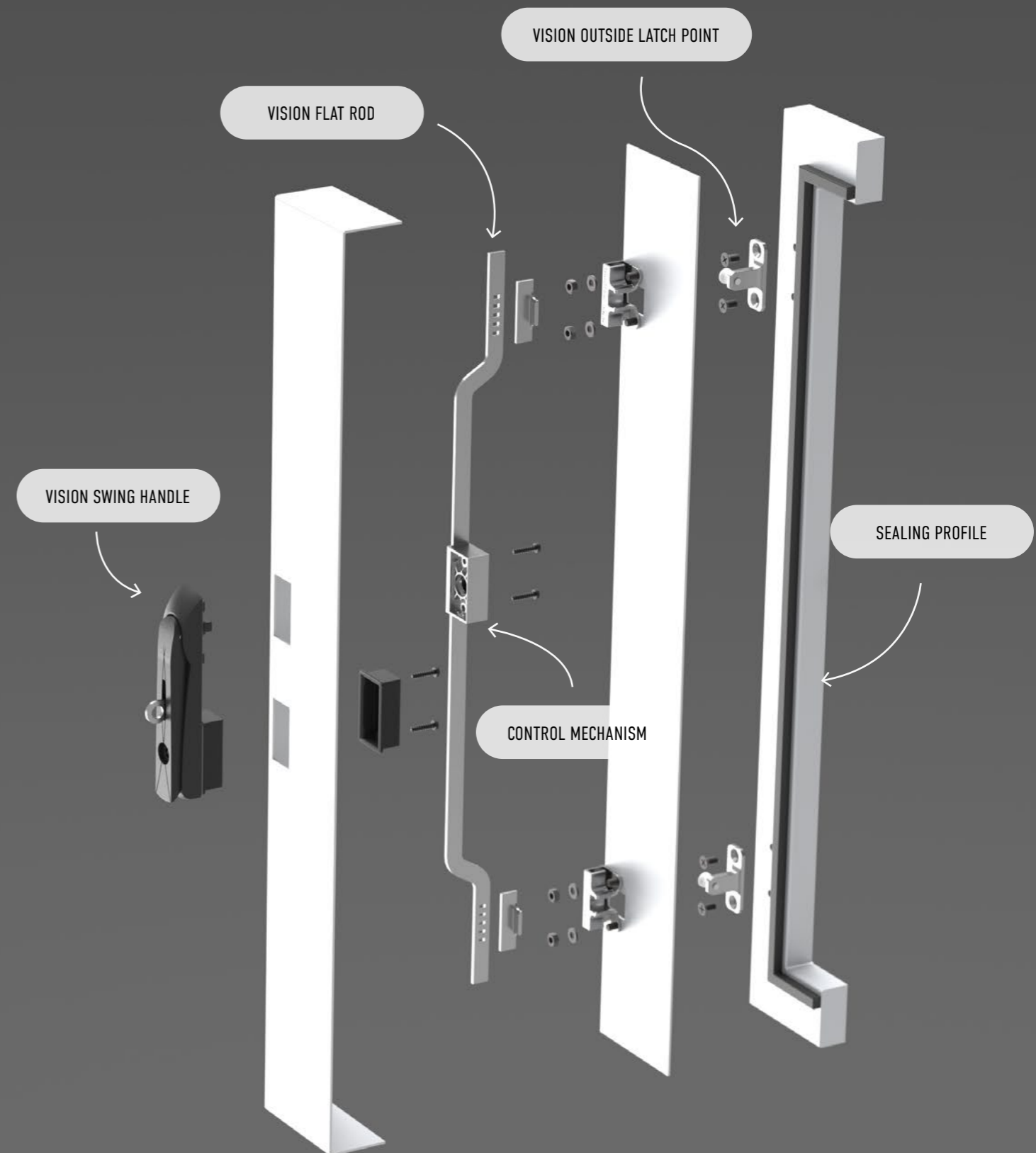

DELIVERING ACCESS EXCELLENCE

At Industrilas, every step in the production chain is done in-house, from design and the casting of metal - to the finishing touches. Because we do everything in-house, our customers can rest assured that we deliver what we promise. It also gives customers a direct, hands-on connection to the actual development of their solutions.

Industrilas manufacturing includes:

- × Design and Construction Department
- × Quality Department
- × Tool Department
- × Turning
- × Zinc Foundry
- × Injection Moulding and PUR Gasketing
- × Punching and Bending
- × Drilling and Threading
- × Powder Coating
- × Assembly
- × Warehouse

STANDARDS ARE IMPORTANT

To be seen as the most trustworthy partner in the business, year after year, we need to deliver what we promise. To ensure continuity, our processes must meet quality standards, sustainability regulations and industry demands.

Industrilas holds an AAA rating, we follow the REACH and RoHS directives, and our quality management systems are certified to IATF 16949, ISO 9001 and ISO 14001.



A MORE SUSTAINABLE TOMORROW

To lead by example, it is not enough to follow international standards and laws on sustainability. We have to improve every part of our business, from raw materials and production processes to energy sourcing and transport.

Industrias has always challenged tradition and explored new ideas. The same approach will lead us to find sustainable solutions that will change the way people look at our industry. Solutions that will benefit us, our customers and the world.

One step at a time, every day, towards a more sustainable tomorrow.

SUSTAINABILITY POLICY*

Sustainable development is development that meets the needs of the present without compromising the ability of future generations to meet their own needs.

ENVIRONMENTAL

We are aware of our responsibility towards people and nature, and we want to minimize the effect that our actions might have on the environment. We aim to reduce consumption of natural resources, reduce production and process waste, and increase our share of renewable energy.

SOCIAL

All humans are equal and have the same value and rights. Industrias has an absolute zero-tolerance policy towards all forms of discrimination, and we continuously work to curb the presence of inequality and discrimination in our community and globally.

ECONOMIC

Industrias shall provide the conditions to ensure long-lasting sustainable development, prosperity for the company and value for our customers. We follow local and global laws and standards and have a zero-tolerance policy towards any kind of behaviour that conflicts with good business ethics.

*This is an excerpt from Industrias' Sustainability Policy. The complete version is available at industrias.com.



WORLDWIDE PRESENCE

Industralas is growing like never before and to service the world; strategic manufacturing, sustainable logistics and local presence are vital.

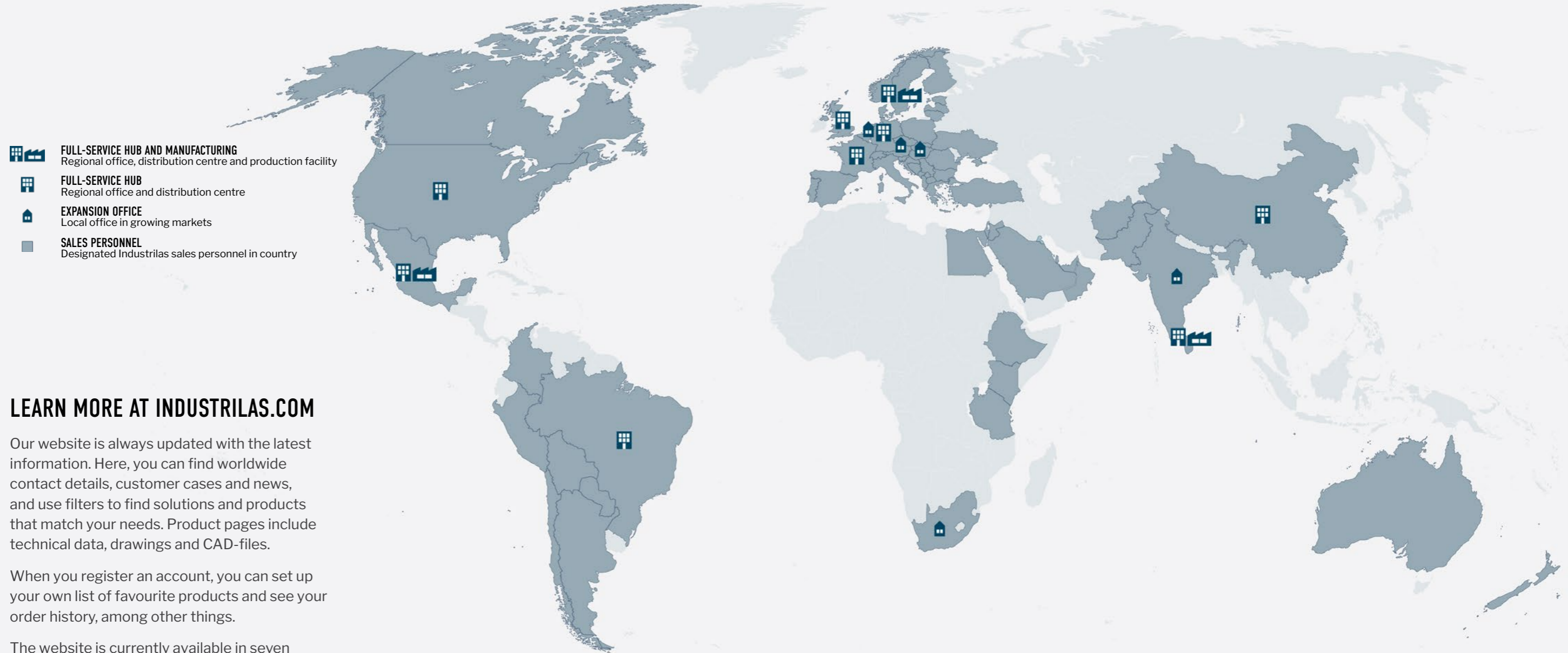

LEARN MORE AT INDUSTRILAS.COM

Our website is always updated with the latest information. Here, you can find worldwide contact details, customer cases and news, and use filters to find solutions and products that match your needs. Product pages include technical data, drawings and CAD-files.

When you register an account, you can set up your own list of favourite products and see your order history, among other things.

The website is currently available in seven languages.

FOLLOW US ON SOCIAL MEDIA

Industralas is very active in social media where we share and discuss company news and events, customer accomplishments, industry highlights and innovations. Follow us at LinkedIn and Facebook and join the community.

Today, we are represented in more than 40 countries and have manufacturing facilities on three continents: Europe, Central America and Asia. We have nine full-service hubs with distribution centres: Brazil, China, France, Germany, Great Britain, Mexico, Sri Lanka, Sweden, and USA. Our latest expansion offices were opened in Austria, Benelux, Hungary, India and South Africa.



WHEN ACCESS COUNTS

Industrilas develops, designs and manufactures access solutions for all kinds of industrial applications.

Our main drive is a never-ending curiosity about our customers and their business. We are passionate about finding solutions that will enhance the performance of our customers' products and their business.

Since every customer has specific needs and preferences, it is important for us to get to know our customers. We openly welcome you into the Industrilas family, and together we will find the best possible solution to the challenges you are facing. Sometimes this means a well-proven standard solution and at other times it means the innovation of something the world has never seen.

Industrilas is a Swedish company, founded in 1981. Over the course of 40 years, we have grown from a one-person startup to become one of the world's leading suppliers of access solutions. Today, we are present in more than 40 countries and have manufacturing sites in Europe, Asia and Central America.

The group's head office is in Nässjö, Sweden.