

# CLÉS POUR INSERT



Fourni avec une fente pour un porte-clés. La clé peut être produite avec le logo de votre entreprise sur demande.

Forme de clé A

Utilisée avec des loquets standard quart de tour.

Forme de clé B

Peut être utilisée avec des loquets quart de tour standard ou compacts.



## MATÉRIAU

**Key:** Glass fibre reinforced Polyamide (PA6GF30), black

## RELATED PRODUCTS

**Needed components for a complete system:**

2-070

Use the Index Code at [industrilas.com](http://industrilas.com)

## TESTS & STANDARDS

Other colours on request.

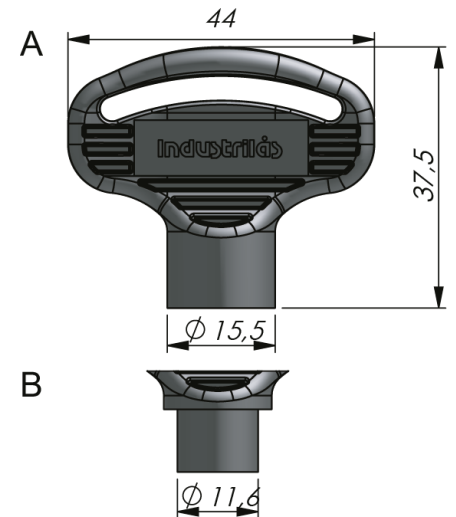
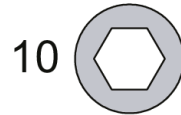
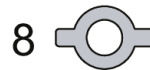
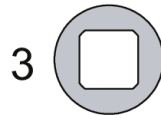
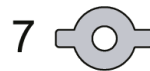
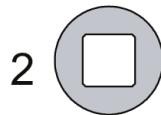
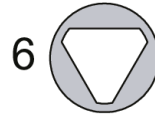
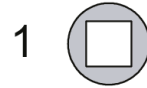

**IndustriLas**  
— When access counts —

P/N	For insert	Shape	Dessin
29501001	Carré 6	B	1
29501002	Carré 7	B	2
29501003	Carré 8	B	3
29501004	Triangle 6,5	B	13
29501005	Triangle 7	A	4
29501006	Triangle 8	A	5
29501007	Triangle 10	A	6
29501008	Double panneton 3	A	7
29501009	Double panneton 5	A	10
29501010	Hexagone 8,5	A	10
29501011	Triangle 10 / radius	A	9
29501012	Recessed hexagon 8/3 mm pin	B	11
29501013	Carré encastré 8	A	15