

# NYCKLAR FÖR INSATS



Förberedda med hål för nyckelring. Nyckeln kan mot förfrågan tillverkas med din företagslogotyp.

## Nyckelform A

Används med standardkvartsvarvslås.

## Nyckelform B

Kan användas med antingen standardkvartsvarvslås eller Compact-kvartsvarvslås.



### MATERIAL

**Nyckel:** Polyamid glasfaserverstärk (PA6), schwarz

### RELATERADE PRODUKTER

**Needed components for a complete system:**

2-070

Use the Index Code at [industrilas.com](http://industrilas.com)

### TESTS & STANDARDS

Other colours on request.

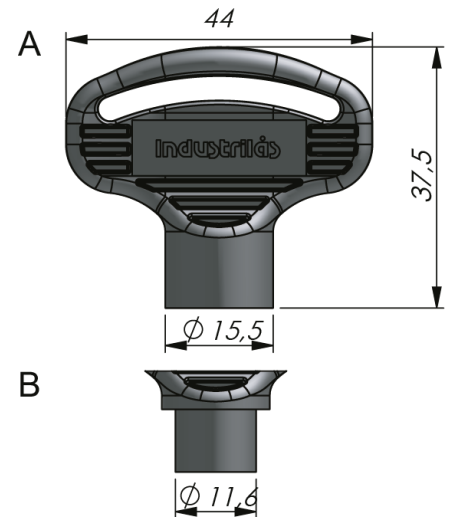
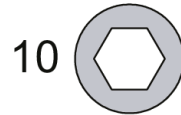
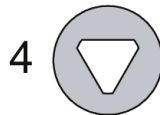
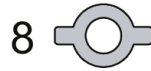
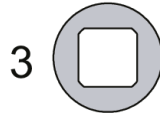
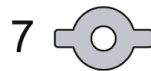
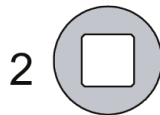
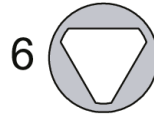
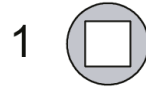

**Industrilas**  
— When access counts —

Artikelnummer	För insats	Shape	Ritning
29501001	Fyrkant 6	B	1
29501002	Fyrkant 7	B	2
29501003	Fyrkant 8	B	3
29501004	Trekant 6,5	B	13
29501005	Trekant 7	A	4
29501006	Trekant 8	A	5
29501007	Trekant 10	A	6
29501008	Double bit 3	A	7
29501009	Double bit 5	A	10
29501010	Hexagon 8,5	A	10
29501011	Triangle 10 / radius	A	9
29501012	Recessed hexagon 8/3 mm pin	B	11
29501013	Recessed square 8	A	15