

SINGLE-POINT CAMS SS 316

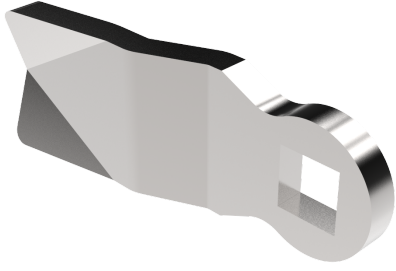

Single-point cams for use with housings with internal limitation of rotation.

In the drawing, C = housing length, H = outside face to engagement point of cam.

Other lengths and versions available on request.



MATERIAL

Cam: Stainless steel 316

RELATED PRODUCTS

Other materials: 2-481

Protective cap: 2-480

Use the Index Code at industralas.com

TECHNICAL INFORMATION

H in mm when housing length C=12, 18, 30, 35, 45 or 56 mm.

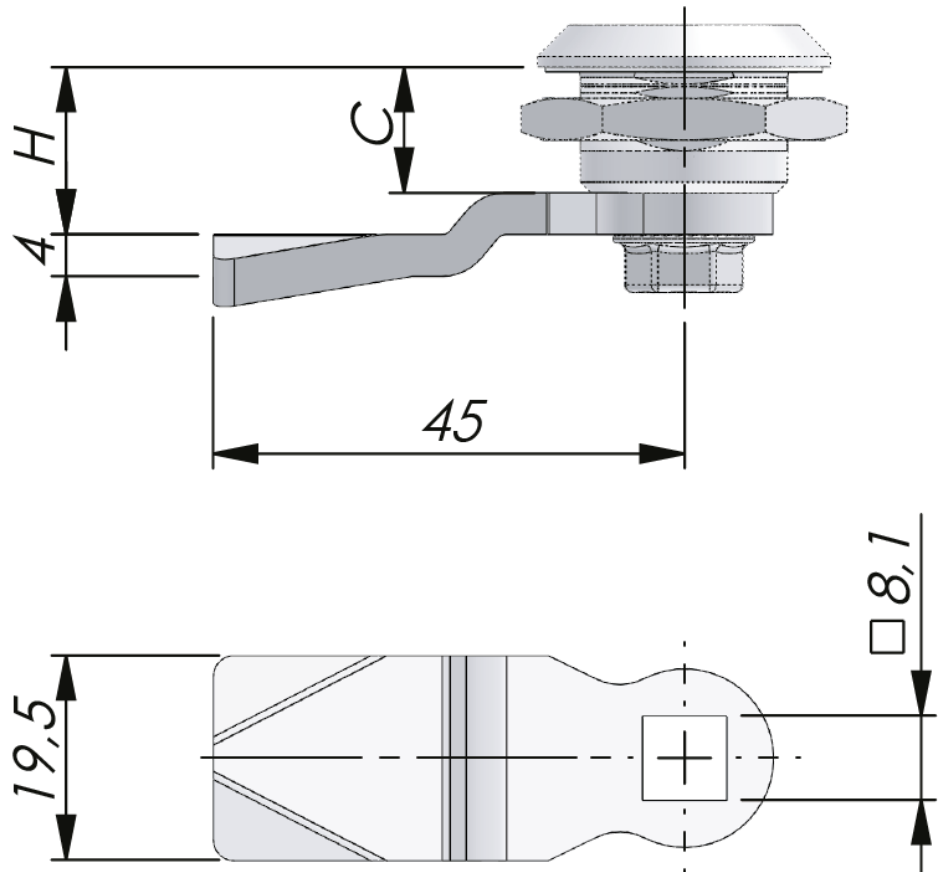

INDUSTRILAS.COM

P/N	Description	C=12	C=18	C=30	C=35	C=45	C=56
239001-U	---	-	4	16	21	31	42
239002-U	---	-	6	18	23	33	44
239003-U	---	2	8	20	25	35	46
239004-U	---	4	10	22	27	37	48
239005-U	---	6	12	24	29	39	50
239007-U	---	8	14	26	31	41	52
239008-U	---	10	16	28	33	43	54
239009-U	Straight cam	12	18	30	35	45	56
239010-U	---	14	20	32	37	47	58
239011-U	---	16	22	34	39	49	60
239012-U	---	18	24	36	41	51	62
239014-U	---	20	26	38	43	53	64
239015-U	---	22	28	40	45	55	66
239016-U	---	24	30	42	47	57	68
239017-U	---	26	32	44	49	59	70
239018-U	---	28	34	46	51	61	72
239020-U	---	30	36	48	53	63	74
239021-U	---	32	38	50	55	65	76
239022-U	---	34	40	52	57	67	78
239023-U	---	36	42	54	59	69	80
239024-U	---	38	44	56	61	71	82
239027-U	---	44	50	62	67	77	88
239031-U	---	40	46	58	63	73	84
239072-U	---	42	48	60	65	75	86

H in mm when housing length C=12, 18, 30, 35, 45 or 56 mm.